



SHENEY & CO.
AVIATION COVERS



PRODUCT AND SERVICE CATALOGUE 2018

-Trusted for more than 10 years-



CONTENTS

Our Mission & About Us	4
<u>Helicopter Covers</u>	
Insulated Cover Design	7
Bell 206 A/B	8
Bell 206 L	9
Bell 407	10
Bell 204	11
Bell 205-A1/UH-1H	12
Bell 212	13
Bell 412	14
Bell 214 ST	15
AS 350	16
AS 350	17
AS 355	18
<u>Helicopter Interiors</u>	19
Seat Refurbishing	20
Protective Seat Covers / Troop Seats	21
Acoustic Walls	21
Carpet/Paneling	22
Bell 205 Stanchions	23





Cargo

Utility/Refueling Bag	24
Bell Dual Control Case	24
Emergency Stretcher Case	25

Material Samples

Leather Seating	27
Sheep Wool/ Hide Colours	28
Carpet	29
Fabrics	29
Corporate Leather	30
Sheep Wool Seat Covers	31



Our Mission

We believe that quality materials and craftsmanship are top priority and we will continuously look to provide new aviation solutions. We always put the client first and work to ensure long-term relationships.

About Us

Sheney & Co was started over 10 years ago. Working together with my wife, we successfully designed an all new helicopter insulated cover with the help of some great (and very qualified) textile designers. Our products have consistently shown to be of top quality and our shop. Our commitment to providing quality products alongside top quality service. We have been the premier go-to shop for the aviation industry for over 10 years. We invite you to review our product catalog, and look forward to meeting your aviation cover-product needs.

We specialize in Aviation protective covers, exterior plugs, interior upholstery, carpet kits, seat covers and more. Please have a look at our catalog for a detailed description of what we manufacture right here in Kingston Ontario Canada.

Sincerely,

Jason & Milca Sheney



Below are some examples of our craftsmanship and quality:



Bell 214ST Engine Cover

Bell 205 Engine & Blade Covers



Bell 206 Blade Tie Down

HELICOPTER COVERS

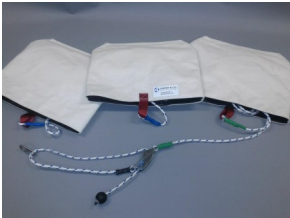

AS350 Blade Tie Downs



Bell 214ST Engine & Head Cover



Bell 206 Exhaust Covers



Bell 205 Engine, Head & Blade Covers



AS350 Engine, Head & Blade Covers



Bell 206 Tail Rotor Cover



Bell 206 Blade Tie Down



Bell 205 Tail Rotor & Gear Box Cover

INSULATED COVER DESIGN

THINSULATE™

The original warmth without the bulk. Inch for inch, no other insulation keeps you warmer than Thinsulate. When you compare equal thicknesses, Thinsulate Insulation provides up to twice the warmth of other high-loft insulating materials and nearly one and a half times the warmth of down.



CORDURA™

CORDURA® fabric is what many of the most respected brands, retailers and militaries around the world use when they need to make a product that's durable, versatile and reliable. Constructed using high tenacity fiber technologies, weight for weight CORDURA® fabrics are exceptionally durable.



No matter the application, our fabrics are simply "best-in-class."



BELL 206 JET RANGER



Bell 206 Range Extender

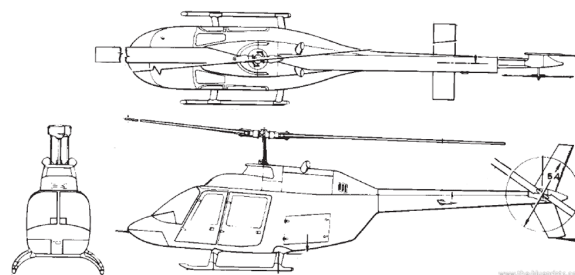

Bell 206 Range Extender

Catalog #	Description	Aircraft model
COV-206B-001	Blade Cover Kit, Heavy Duty Version	Bell 206B
COV-206B-002	Blade Cover Kit, Tarpaulin Version	Bell 206B
COV-206B-003	Blade Tie Down, High Wind Applications	Bell 206B
COV-206B-004	Engine Cover, Insulated	Bell 206B
COV-206B-005	Engine Cover, Non-Insulated	Bell 206B
COV-206B-006	Exhaust Cover Kit	Bell 206B
COV-206B-007	Head / Mast Cover, Insulated	Bell 206B
COV-206B-008	Head / Mast Cover, Non-Insulated	Bell 206B
COV-206B-009	Intake Plug Kit	Bell 206B
COV-206B-010	Pitot Protective Cover	Bell 206B
COV-206B-011	Vertical Stabilizer Cover Kit, Heavy Duty Version	Bell 206B
COV-206B-012	Vertical Stabilizer Cover Kit, Protective Padding	Bell 206B
COV-206B-013	Vertical Stabilizer Cover Kit, Tarpaulin Version	Bell 206B
COV-206B-014	Tail Rotor Cover, Heavy Duty Version	Bell 206B
COV-206B-015	Tail Rotor Cover, Tarpaulin Version	Bell 206B
COV-206B-016	Windshield Protective Cover	Bell 206B
COV-206B-017	Range Extender Cover	Bell 206B

BELL 206 LONG RANGER



Bell 206 Tail Rotor Cover

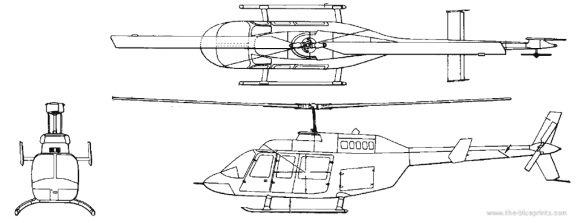

Bell 206 Blade Tie Down

Catalog #	Description	Aircraft model
COV-206L-001	Blade Cover Kit, Heavy Duty Version	Bell 206L
COV-206L-002	Blade Cover Kit, Tarpaulin Version	Bell 206L
COV-206L-003	Blade Tie Down, High Wind Applications	Bell 206L
COV-206L-004	Engine Cover, Insulated	Bell 206L
COV-206L-005	Engine Cover, Non-Insulated	Bell 206L
COV-206L-006	Exhaust Cover Kit (L3 & L4)	Bell 206L
COV-206L-007	Exhaust Cover Kit	Bell 206L
COV-206L-008	Head / Mast Cover, Insulated	Bell 206L
COV-206L-009	Head / Mast Cover, Non-Insulated	Bell 206L
COV-206L-010	Intake Plug Kit	Bell 206L
COV-206L-011	Pitot Protective Cover	Bell 206L
COV-206L-012	Vertical Stabilizer Cover Kit, Heavy Duty Version	Bell 206L
COV-206L-013	Vertical Stabilizer Cover Kit, Protective Padding	Bell 206L
COV-206L-014	Vertical Stabilizer Cover Kit, Tarpaulin Version	Bell 206L
COV-206L-015	Tail Rotor Cover, Heavy Duty Version	Bell 206L
COV-206L-016	Tail Rotor Cover, Tarpaulin Version	Bell 206L
COV-206L-017	Windshield Protective Cover	Bell 206L
COV-206L-018	Range Extender Cover	Bell 206L

BELL 407

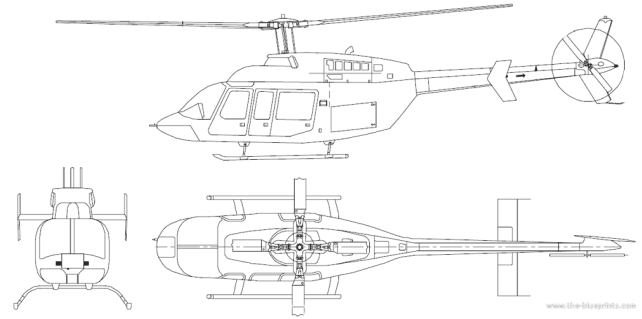

Catalog #	Description	Aircraft model
COV-407-001	Blade Cover Kit, Heavy Duty Version	Bell 407
COV-407-002	Blade Cover Kit, Tarpaulin Version	Bell 407
COV-407-003	Blade Tie Down Kit	Bell 407
COV-407-004	Engine Cover, Insulated	Bell 407
COV-407-005	Engine Cover, Non-Insulated	Bell 407
COV-407-006	Exhaust Cover Kit	Bell 407
COV-407-007	Head / Mast Cover, Insulated	Bell 407
COV-407-008	Head / Mast Cover, Non-Insulated	Bell 407
COV-407-009	Intake Plug Kit	Bell 407
COV-407-010	Pitot Protective Cover	Bell 407
COV-407-011	Stabilizer Cover Kit, Heavy Duty Version	Bell 407
COV-407-012	Stabilizer Cover Kit, Protective Padding Version	Bell 407
COV-407-013	Stabilizer Cover Kit, Tarpaulin Version	Bell 407
COV-407-014	Tail Rotor Cover, Heavy Duty Version	Bell 407
COV-407-015	Tail Rotor Cover, Tarpaulin Version	Bell 407
COV-407-016	Windshield Protective Cover	Bell 407
COV-407-017	Range Extender Cover	Bell 407
COV-407-018	Tail Rotor Tie Down	Bell 407

BELL 204



Bell 204 Tail Rotor Cover



Bell 204 Engine Cover



Catalog #	Description	Aircraft model
COV-204-001	Blade Cover Kit, Heavy Duty Version	Bell 204
COV-204-002	Blade Cover Kit, Tarpaulin Version	Bell 204
COV-204-003	Blade Tie Down High Wind Application	Bell 204
COV-204-004	Engine Cover, Insulated	Bell 204
COV-204-005	Engine Cover, Non-Insulated	Bell 204
COV-204-006	Exhaust Cover	Bell 204
COV-204-007	Head / Mast Cover, Insulated	Bell 204
COV-204-008	Head / Mast Cover, Non-Insulated	Bell 204
COV-204-009	Intake Plug Kit	Bell 204
COV-204-010	Pitot Protective Cover Kit	Bell 204
COV-204-011	Stabilizer Cover Kit, Heavy Duty Version	Bell 204
COV-204-012	Stabilizer Cover Kit, Protective Padding Version	Bell 204
COV-204-013	Stabilizer Cover Kit, Tarpaulin Version	Bell 204
COV-204-014	Vertical Stabilizer Cover, Heavy Duty Version	Bell 204
COV-204-015	Vertical Stabilizer Cover, Protective Padding Version	Bell 204
COV-204-016	Vertical Stabilizer Cover, Tarpaulin Version	Bell 204
COV-204-017	Tail Rotor Cover, Heavy Duty Version	Bell 204
COV-204-018	Tail Rotor Cover, Tarpaulin Version	Bell 204
COV-204-019	Windshield Protective Cover	Bell 204
COV-204-020	Tail Rotor Tie Down	Bell 204
COV-204-021	Window Plug	Bell 204

BELL 205-1A / UH-1H / HUEY

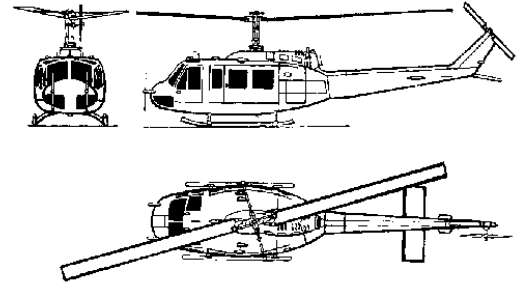

Catalog #	Description	Aircraft model
COV-205-001	Blade Cover Kit, Heavy Duty Version	Bell 205
COV-205-002	Blade Cover Kit, Tarpaulin Version	Bell 205
COV-205-003	Blade Tie Down High Wind Application	Bell 205
COV-205-004	Engine Cover, Insulated	Bell 205
COV-205-005	Engine Cover, Non-Insulated	Bell 205
COV-205-006	Exhaust Cover	Bell 205
COV-205-007	Head / Mast Cover, Insulated	Bell 205
COV-205-008	Head / Mast Cover, Non-Insulated	Bell 205
COV-205-009	Intake Plug Kit	Bell 205
COV-205-010	Pitot Protective Cover	Bell 205
COV-205-011	Stabilizer Cover Kit, Heavy Duty Version	Bell 205
COV-205-012	Stabilizer Cover Kit, Protective Padding Version	Bell 205
COV-205-013	Stabilizer Cover Kit, Tarpaulin Version	Bell 205
COV-205-014	Vertical Stabilizer Cover, Heavy Duty Version	Bell 205
COV-205-015	Vertical Stabilizer Cover, Protective Padding Version	Bell 205
COV-205-016	Vertical Stabilizer Cover, Tarpaulin Version	Bell 205
COV-205-017	Tail Rotor Cover, Heavy Duty Version	Bell 205
COV-205-018	Tail Rotor Cover, Tarpaulin Version	Bell 205
COV-205-019	Windshield Protective Cover	Bell 205
COV-205-020	Tail Rotor Tie Down	Bell 205
COV-205-021	Window Plug	Bell 205

BELL 212

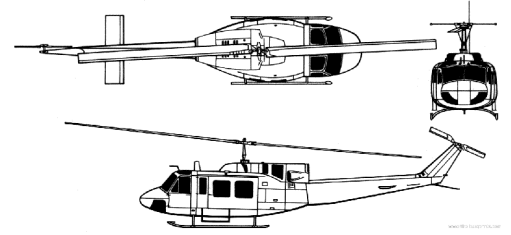

Catalog #	Description	Aircraft model
COV-212-001	Blade Cover Kit, Heavy Duty Version	Bell 212
COV-212-002	Blade Cover Kit, Tarpaulin Version	Bell 212
COV-212-003	Blade Tie Down High Wind Application	Bell 212
COV-212-004	Engine Cover, Insulated	Bell 212
COV-212-005	Engine Cover, Non-Insulated	Bell 212
COV-212-006	Exhaust Cover	Bell 212
COV-212-007	Head / Mast Cover, Insulated	Bell 212
COV-212-008	Head / Mast Cover, Non-Insulated	Bell 212
COV-212-009	Intake Plug Kit	Bell 212
COV-212-010	Pitot Protective Cover	Bell 212
COV-212-011	Stabilizer Cover Kit, Heavy Duty Version	Bell 212
COV-212-012	Stabilizer Cover Kit, Protective Padding Version	Bell 212
COV-212-013	Stabilizer Cover Kit, Tarpaulin Version	Bell 212
COV-212-014	Vertical Stabilizer Cover, Heavy Duty Version	Bell 212
COV-212-015	Vertical Stabilizer Cover, Protective Padding Version	Bell 212
COV-212-016	Vertical Stabilizer Cover, Tarpaulin Version	Bell 212
COV-212-017	Tail Rotor Cover, Heavy Duty Version	Bell 212
COV-212-018	Tail Rotor Cover, Tarpaulin Version	Bell 212
COV-212-019	Windshield Protective Cover	Bell 212
COV-212-020	Tail Rotor Tie Down	Bell 212
COV-212-021	Window Plug	Bell 212

BELL 412

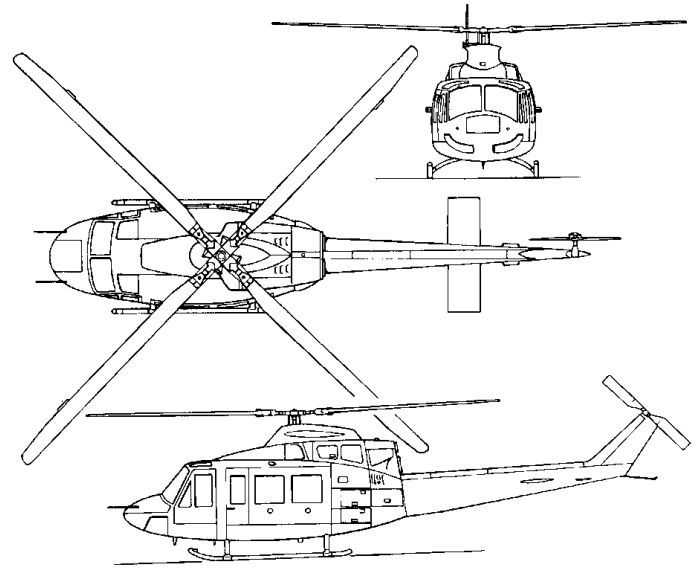

Catalog#	Description	Aircraft model	Cost
COV-412-001	Blade Cover Kit, Heavy Duty Version	Bell 412	
COV-412-002	Blade Cover Kit, Tarpaulin Version	Bell 412	
COV-412-003	Blade Tie Down High Wind Application	Bell 412	
COV-412-004	Engine Cover, Insulated	Bell 412	
COV-412-005	Engine Cover, Non-Insulated	Bell 412	
COV-412-006	Exhaust Cover	Bell 412	
COV-412-007	Head / Mast Cover, Insulated	Bell 412	
COV-412-008	Head / Mast Cover, Non-Insulated	Bell 412	
COV-412-009	Intake Plug Kit	Bell 412	
COV-412-010	Pitot Protective Cover Kit	Bell 412	
COV-412-011	Stabilizer Cover Kit, Heavy Duty Version	Bell 412	
COV-412-012	Stabilizer Cover Kit, Protective Padding Version	Bell 412	
COV-412-013	Stabilizer Cover Kit, Tarpaulin Version	Bell 412	
COV-412-014	Vertical Stabilizer Cover, Heavy Duty Version	Bell 412	
COV-412-015	Vertical Stabilizer Cover, Protective Padding Version	Bell 412	
COV-412-016	Vertical Stabilizer Cover, Tarpaulin Version	Bell 412	
COV-412-017	Tail Rotor Cover, Heavy Duty Version	Bell 412	
COV-412-018	Tail Rotor Cover, Tarpaulin Version	Bell 412	
COV-412-019	Windshield Protective Cover	Bell 412	
COV-412-020	Tail Rotor Tie Down	Bell 412	
COV-412-021	Window Plug	Bell 412	

BELL 214ST



On-Site Work

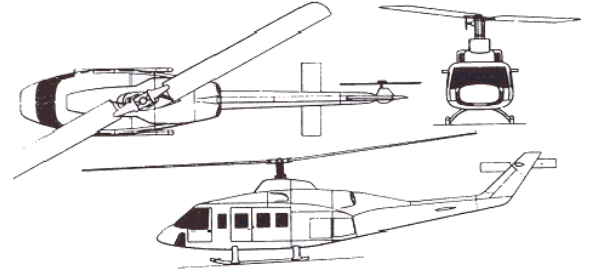

Bell 214ST Engine & Mast Cover

Catalog #	Description	Aircraft model	Cost
COV-214-001	Blade Cover Kit, Heavy Duty Version	Bell 214ST	
COV-214-002	Blade Cover Kit, Tarpaulin Version	Bell 214ST	
COV-214-003	Blade Tie Down High Wind Application	Bell 214ST	
COV-214-004	Engine Cover, Insulated	Bell 214ST	
COV-214-005	Engine Cover, Non-Insulated	Bell 214ST	
COV-214-006	Exhaust Cover	Bell 214ST	
COV-214-007	Head / Mast Cover, Insulated	Bell 214ST	
COV-214-008	Head / Mast Cover, Non-Insulated	Bell 214ST	
COV-214-009	Intake Plug Kit	Bell 214ST	
COV-214-010	Pitot Protective Cover	Bell 214ST	
COV-214-011	Stabilizer Cover Kit, Heavy Duty Version	Bell 214ST	
COV-214-012	Stabilizer Cover Kit, Protective Padding Version	Bell 214ST	
COV-214-013	Stabilizer Cover Kit, Tarpaulin Version	Bell 214ST	
COV-214-014	Vertical Stabilizer Cover, Heavy Duty Version	Bell 214ST	
COV-214-015	Vertical Stabilizer Cover, Protective Padding Version	Bell 214ST	
COV-214-016	Vertical Stabilizer Cover, Tarpaulin Version	Bell 214ST	
COV-214-017	Tail Rotor Cover, Heavy Duty Version	Bell 214ST	
COV-214-018	Tail Rotor Cover, Tarpaulin Version	Bell 214ST	
COV-214-019	Windshield Protective Cover	Bell 214ST	
COV-214-020	Tail Rotor Tie Down	Bell 214ST	

EUROCOPTER AS350 (PART 1)

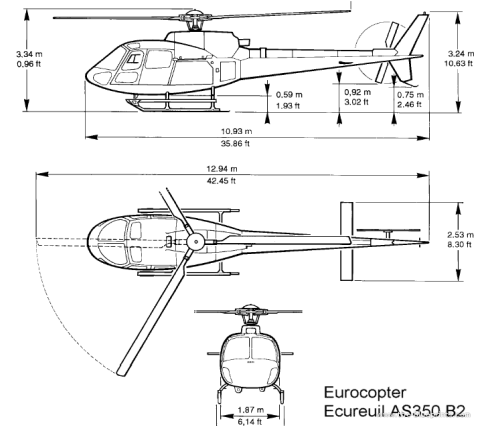

Catalog #	Description	Aircraft model	Cost
COV-350-001	Blade Cover Kit, Heavy Duty Version	AS 350	
COV-350-002	Blade Cover Kit, Tarpaulin Version	AS 350	
COV-350-003	Blade Tie Down, High Wind Applications	AS 350	
COV-350-004	Engine Cover, Insulated (model B1)	AS 350	
COV-350-005	Engine Cover, Insulated (model B2)	AS 350	
COV-350-006	Engine Cover, Insulated (model B3)	AS 350	
COV-350-007	Engine Cover, Insulated (model D)	AS 350	
COV-350-008	Engine Cover, Non-Insulated (model B1)	AS 350	
COV-350-009	Engine Cover, Non-Insulated (model B2)	AS 350	
COV-350-010	Engine Cover, Non-Insulated (model B3)	AS 350	
COV-350-011	Engine Cover, Non-Insulated (model D)	AS 350	
COV-350-012	Head/Mast Cover, Insulated (model B1)	AS 350	
COV-350-013	Head/Mast Cover, Insulated (model B2)	AS 350	
COV-350-014	Head/Mast Cover, Insulated (model B3)	AS 350	
COV-350-015	Head/Mast Cover, Insulated (model D)	AS 350	
COV-350-016	Head/Mast Cover, Non-Insulated (model B1)	AS 350	
COV-350-017	Head/Mast Cover, Non-Insulated (model B2)	AS 350	

EUROCOPTER AS350 (PART 2)

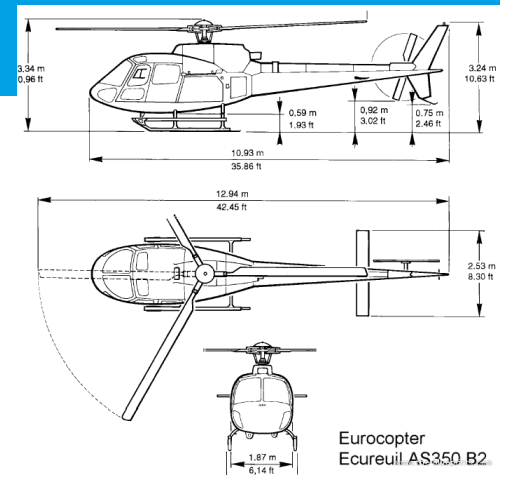

Catalog #	Description	Aircraft model	Cost
COV-350-018	Head/Mast Cover, Non-Insulated (model B3)	AS 350	
COV-350-019	Head/Mast Cover, Non-Insulated (model D)	AS 350	
COV-350-020	Intake Cover (model B)	AS 350	
COV-350-021	Intake/Exhaust Cover (model B1)	AS 350	
COV-350-022	Intake Cover (model D)	AS 350	
COV-350-023	Intake/Exhaust Cover (model B2)	AS 350	
COV-350-024	Intake/Exhaust Cover (model B3)	AS 350	
COV-350-025	Pitot Protective Cover	AS 350	
COV-350-026	Horizontal Stabilizer Cover Kit, Heavy Duty Version	AS 350	
COV-350-027	Horizontal Stabilizer Cover Kit, Protective Padding	AS 350	
COV-350-028	Horizontal Stabilizer Cover Kit, Tarpaulin Version	AS 350	
COV-350-029	Tail Rotor Cover, Heavy Duty Version	AS 350	
COV-350-030	Tail Rotor Cover, Tarpaulin Version	AS 350	
COV-350-031	Windshield Protective Cover	AS 350	
COV-350-032	Exhaust Cover, (model B1)	AS 350	
COV-350-033	Exhaust Cover, (model B2, B3)	AS 350	
COV-350-034	Exhaust Cover, (model D)	AS 350	

EUROCOPTER AS355

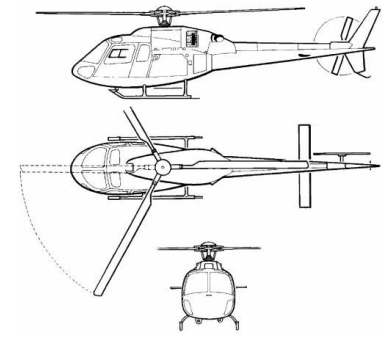

AS355 Engine, Mast, Blasé & Tail Rotor Covers

Catalog #	Description	Aircraft model	Cost
COV-350-018	Head/Mast Cover, Non-Insulated (model B3)	AS 350	
COV-350-019	Head/Mast Cover, Non-Insulated (model D)	AS 350	
COV-350-020	Intake Cover (model B)	AS 350	
COV-350-021	Intake/Exhaust Cover (model B1)	AS 350	
COV-350-022	Intake Cover (model D)	AS 350	
COV-350-023	Intake/Exhaust Cover (model B2)	AS 350	
COV-350-024	Intake/Exhaust Cover (model B3)	AS 350	
COV-350-025	Pitot Protective Cover	AS 350	
COV-350-026	Horizontal Stabilizer Cover Kit, Heavy Duty Version	AS 350	
COV-350-027	Horizontal Stabilizer Cover Kit, Protective Padding	AS 350	
COV-350-028	Horizontal Stabilizer Cover Kit, Tarpaulin Version	AS 350	
COV-350-029	Tail Rotor Cover, Heavy Duty Version	AS 350	
COV-350-030	Tail Rotor Cover, Tarpaulin Version	AS 350	
COV-350-031	Windshield Protective Cover	AS 350	
COV-350-032	Exhaust Cover, (model B1)	AS 350	
COV-350-033	Exhaust Cover, (model B2, B3)	AS 350	
COV-350-034	Exhaust Cover, (model D)	AS 350	

HELICOPTER INTERIORS



Interiors

We have been successfully doing interior refurbishments for the aviation industry for over 10 years, and all of our interior products come with the required Certificate of Conformance and are of quality workmanship.

Choose from the included material sample sheets on pages 27— 31, or let us know your preference and we will help you find what you're looking for. Please contact us for further information and pricing.

Seat Refurbishing

All seat refurbishing includes new materials and foam that meets FAR 25.853, along with 12 and 60 Second Vertical Testing.



Protective Seat Covers & Passenger Troop Seats

All of our protective seat covers have been designed to fit the original seating and we carry seat covers for most helicopters. All materials used in the refurbishing process comply to FAR 29.853(a) and 25.8539(a). Additional flame testing is available depending on your certification requirements.



Acoustic Walls

All materials used in the refurbishing process comply to FAR 29.853(a) and 25.8359(a). Additional flame testing is available depending on your certification requirements.



Carpet & Paneling

We have a large selection of carpet kits and interior paneling suitable for most helicopters. All materials used in the refurbishing process comply to FAR 29.853(a) and 25.8359(a). Additional flame testing is available depending on your certification requirements.



Bell 205 Stanchions

All materials used in the refurbishing process comply to FAR 29.853(a) and 25.8359(a).

Included with the finished product is a Certificate of Conformance and pertaining documents. Additional flame testing is available depending on your certification requirements.



Cargo



Refueling Kit Bag

Double lined with fuel resistant material, will not leak from fuel spillage. 1 year warranty.

Built by Sheney & Co. Manufacturing

Dual Controls Case

Controls secured in place within a hard case to prevent flexing. 5 year warranty.

Built by Sheney & Co. Manufacturing



Emergency Stretcher Carrying Case

Padded, 2-step securing system with an easily accessible carrying handle. 5 year warranty.

Built by Sheney & Co. Manufacturing



Sheep Wool / Hide Seat Covers

Sheney & Co. Manufacturing proudly manufactures top, medical-grade sheep hide seat covers that are securely fastened to the seat at five points. Covers are available for all seat models, and come with a 5 year warranty.



Materials



LEATHER SEATING COLOR CHART

SHEEP WOOL / HIDE COLORS



CARPET COLOR CHART

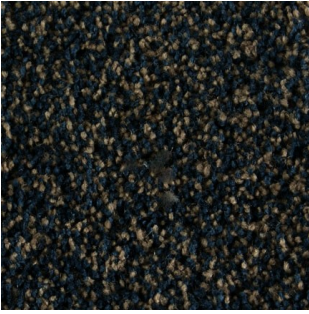

TAUPE

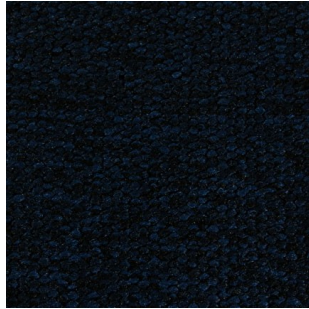

BLACK

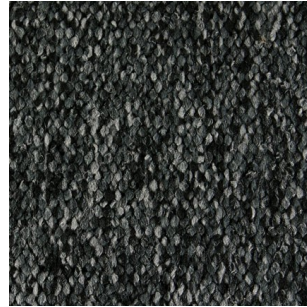

GRANITE



DARK BLUE

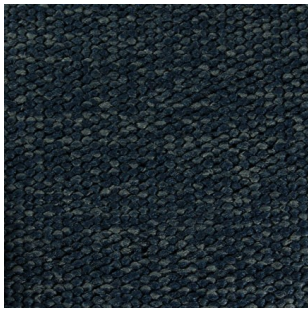

ALANTIC



GREY



GREY BLACK

FABRIC COLOR CHART



BROWN

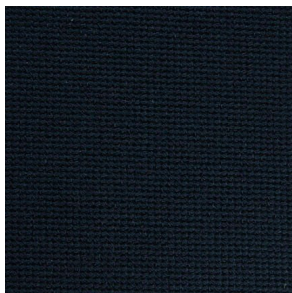

ASH

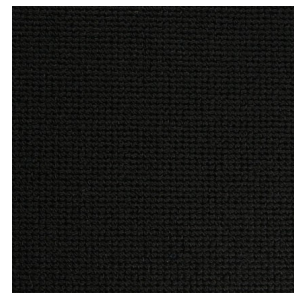

BLACK



MARINE

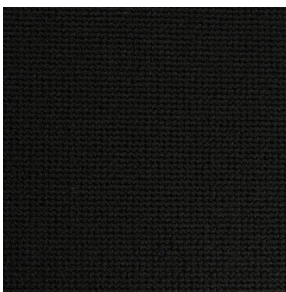

INDIGO



OAT

CORPORATE LEATHER COLOR CHART

(AMONG THE HIGHEST QUALITY LEATHERS IN THE WORLD)



COMORANT

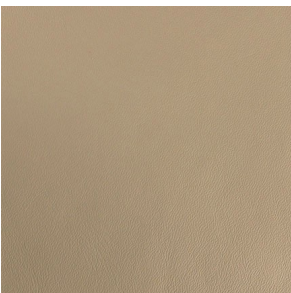

AUCHENTOSHAN



PHANTOM

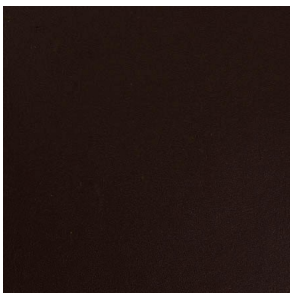

EXPRESSO



TOFFEE



SURMAC

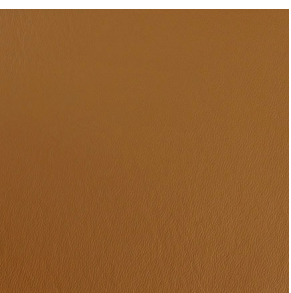

TOFFEE

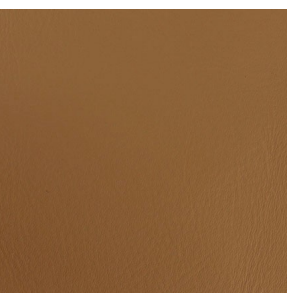

HEMLOCK



BUTTERMILK



PAPAYA



OBSIDAN

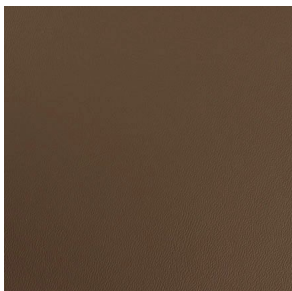

TRUFFLE



TRUFFLE



SNOWFEILD

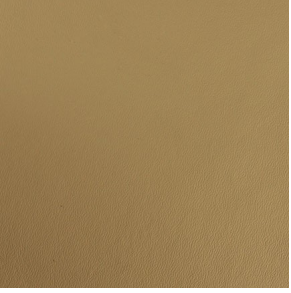

BAMBOO



SUNMAC



DALWHINNIE

In addition to our aircraft-specific products, we do offer specialty products such as:

Long-line Protective Covers

B206 Fuel-Range Extender Covers

B205 Bubble Window Plugs

S61 Bubble Window Plugs

Extreme Weather Blade Covers, available in 100% water proof PVC construction.

If you have any other custom, specific-to-your-aircraft need, please do not hesitate to contact us. We have a team of designers ready to take on your challenge.

Custom work and embroidery are available on-site.

Please contact us for prices.

Toll-free 1 (888) 974-3639 (9SHENEY)

